

Accesorios de Soportería Unicanal Fondo Sólido y Fondo Perforado

El perfil Unicanal es ideal para suspender carga colgante en naves industriales, estacionamientos o centros comerciales. Se pueden utilizar con varillas roscadas o fijarse directamente a una superficie lisa vertical y horizontal

Aplicaciones:

- Utilizada en instalaciones eléctrica de mediana y baja tensión

Características:

- Funcionamiento con abrazaderas Unicanal de la marca Crouse-Hinds para tubería rígida y tubería pared delgada EMT
- Longitud total 3.05 metros (12 pies)
- Medidas disponibles 2cm X 4cm y 4cm X 4cm
- Espesor disponible Cal.14 y Cal.16

Materiales:

- Lámina de Acero Galvanizado

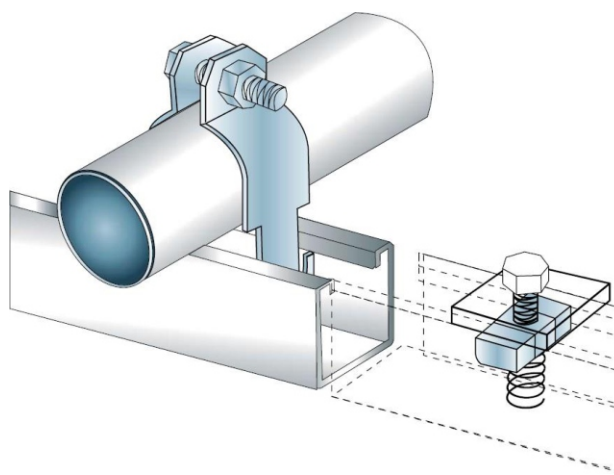









| Catálogo | Código | Espesor | Medida | Empaque | Imagen |
|---|----------|---------|-----------|---------|--------|
| CHB24GALV-120 4 X 4 LISO CAL.14 | 2845056 | Cal.14 | 4cm x 4cm | 10 | |
| CHB26GALV-120 4X4 LISO CAL.16 | 11766810 | Cal.16 | 4cm x 4cm | 10 | |
| CHB24SHGALV-120 4 X 4 PERF. CAL.14 | 2845057 | Cal.14 | 4cm x 4cm | 10 | |
| CHB26GALV-120 4X4 PREF. CAL.16 | 11766811 | Cal.16 | 4cm x 4cm | 10 | |
| CHB54GALV-120 4 X 2 LISO CAL.14 | 2845060 | Cal.14 | 4cm x 2cm | 10 | |
| CHB56GALV-120 4X2 LISO CAL.16 | 11766815 | Cal.16 | 4cm x 2cm | 10 | |
| CHB54SHGALV-120 4 X 2 PERF. CAL.14 | 2845058 | Cal.14 | 4cm x 2cm | 10 | |
| CHB56GALV-120 4X2 PERF. CAL.16 | 11766816 | Cal.16 | 4cm x 2cm | 10 | |

Accesorios de Soportería

Unicanal Fondo Sólido y Fondo Perforado

Especificación y dimensiones

| Catálogo | Espesor (E) | Alto (H) | Ancho (W) | Imagen |
|---|-------------------------|----------|-----------|---|
| CHB24GALV-120 4 X 4 LISO CAL.14 | Cal.14 1.9 mm | 4 cm | 4 cm |  |
| CHB26GALV-120 4X4 LISO CAL.16 | Cal.16 1.5 mm | 4 cm | 4 cm |  |
| CHB24SHGALV-120 4 X 4 PERF. CAL.14 | Cal.14 1.9 mm | 4 cm | 4 cm |  |
| CHB26GALV-120 4X4 PERF. CAL.16 | Cal.16 1.5 mm | 4 cm | 4 cm |  |
| CHB54GALV-120 4 X 2 LISO CAL.14 | Cal.14 1.9 mm | 2 cm | 4 cm |  |
| CHB56GALV-120 4X2 LISO CAL.16 | Cal.16 1.5 mm | 2 cm | 4 cm |  |
| CHB54SHGALV-120 4 X 2 PERF. CAL.14 | Cal.14 1.9 mm | 2 cm | 4 cm |  |
| CHB56GALV-120 4X2 PERF. CAL.16 | Cal.16 1.5 mm | 2 cm | 4 cm |  |

Unicanal Fondo Sólido

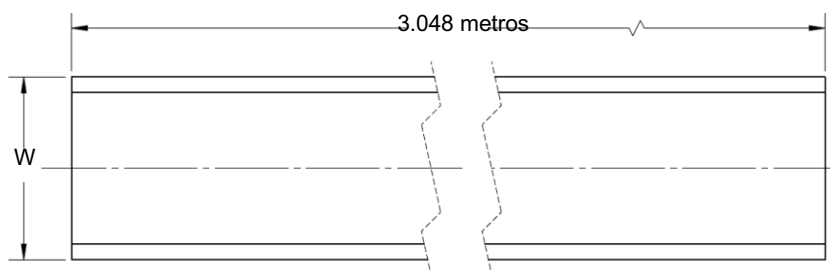
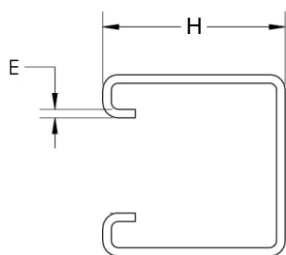

Unicanal Fondo Perforado

